

Strebel PHE Plate Heat Exchangers

Technical Data, Installation, Operating & Maintenance Manual

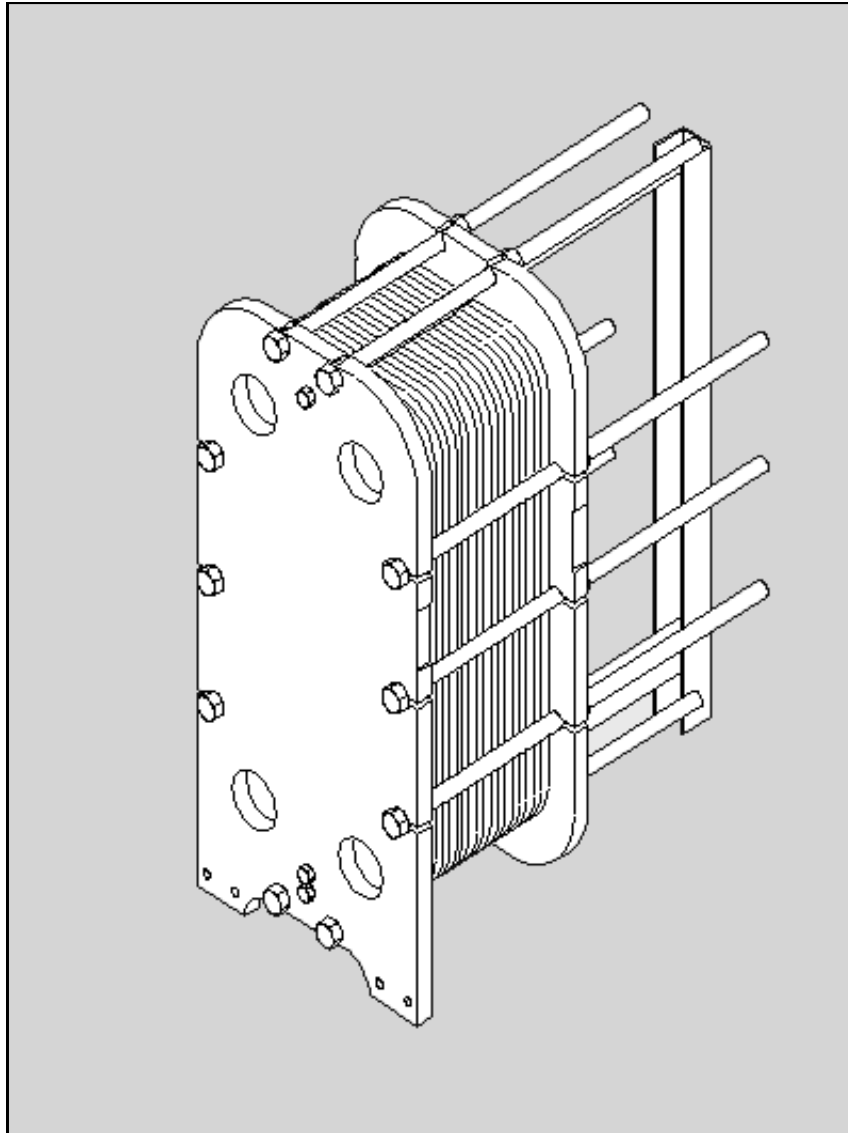

This manual contains essential information with regards to the safe handling, installation, operation and maintenance of the heat exchanger equipment. It is important that the relevant personnel are made aware of this document, and have fully read and understood its contents before becoming involved with heat exchangers of this type. Failure to read the manual may result in misuse, thus resulting in potential injury to personnel and damage to the equipment.

Strebel Ltd

1F Albany Park Industrial Estate
Frimley Road, Camberley,
Surrey, GU16 7PB

Tel: 01276 685 422
Fax: 01276 685 405
Web: www.strebel.co.uk
Email: info@strebel.co.uk

CONTENTS

	PAGE
Detail Drawings	5
PHE 60-120 Plate Heat Exchanger Drawings	6
PHE 150-720 Plate Heat Exchanger Drawings	7
Technical Data Sheets	8
PHE 60	9
PHE 80	10
PHE 100	11
PHE 120	12
PHE 150	13
PHE 160	14
PHE 180	15
PHE 200	16
PHE 240	17
PHE 300	18
PHE 360	19
PHE 400	20
PHE 450	21
PHE 480	22
PHE 500	23
PHE 540	24
PHE 600	25
PHE 720	26
Installation, Operating & Maintenance	27
Installation - General Points	28
Commissioning & Start up	29
Shutting Down the Plate Heat Exchanger	30
Opening the Plate Heat Exchanger	30
Diagrams - Nozzle Designation, Plate Loosening & Tightening Sequences	31
Diagrams - Gasket Types & Plate Types	32
Cleaning of the Plates	33
Plate Types	32
Gaskets	34
Plate Pack Assembly	34
Tightening of the Plate Pack	35
Troubleshooting	36
Maintenance	37

Strebel Ltd

1F Albany Park Industrial Estate
Frimley Road, Camberley,
Surrey, GU16 7PB

Tel: 01276 685 422
Fax: 01276 685 405
Web: www.strebel.co.uk
Email: info@strebel.co.uk

Strebel PHE Plate Heat Exchangers

Detail Drawings

Strebel Ltd

1F Albany Park Industrial Estate
Frimley Road, Camberley,
Surrey, GU16 7PB

Tel: 01276 685 422
Fax: 01276 685 405
Web: www.strebel.co.uk
Email: info@strebel.co.uk

Strebel PHE Plate Heat Exchangers

Technical Data Sheets

Strebel Ltd

1F Albany Park Industrial Estate
Frimley Road, Camberley,
Surrey, GU16 7PB

Tel: 01276 685 422
Fax: 01276 685 405
Web: www.strebel.co.uk
Email: info@strebel.co.uk

Plate Heat Exchanger Data Sheet

Model type: PHE60 (43 plates)

Heat transfer duty (kW): 60

Heat Exchanger circuit - Side 1

Fluid description:	Water
Fluid flow rate (Kg/sec):	0.72
Inlet temperature (Deg C.):	86.0
Outlet temperature (Deg C.):	66.0
Pressure drop (Kpa):	5.9
Inlet / outlet locations:	F1 / F4
Connection size & type:	1.0" BSPT male
Connection material:	316 Stainless
Max. working / test pressure (Bar g.):	6.0 / 9.0
Max. working temperature (Deg C.):	100

Heat Exchanger circuit - Side 2

Fluid description:	Water
Fluid flow rate (Kg/sec):	0.72
Inlet temperature (Deg C.):	62.0
Outlet temperature (Deg C.):	82.0
Pressure drop (Kpa):	5.9
Inlet / outlet locations:	F3 / F2
Connection size & type:	1.0" BSPT male
Connection material:	316 Stainless
Max. working / test pressure (Bar g.):	6.0 / 9.0
Max. working temperature (Deg C.):	100

Constructional Details

Channel Arrangement:	1 x 21 / 1 x 21
Plate material:	0.4 mm / 316 Stainless
Plate type:	Single wall
Gasket material:	Nitrile - clip in
Frame specification:	Steel - painted (2 Pack Acrylic)
Weight empty (Kgs):	53
Hold up volume (Litres):	9
Frame length - Dimension L (mm):	253

Plate Heat Exchanger Data Sheet

Model type: PHE80 (55 plates)

Heat transfer duty (kW): 80

Heat Exchanger circuit - Side 1

Fluid description:	Water
Fluid flow rate (Kg/sec):	0.96
Inlet temperature (Deg C.):	86.0
Outlet temperature (Deg C.):	66.0
Pressure drop (Kpa):	6.6
Inlet / outlet locations:	F1 / F4
Connection size & type:	1.0" BSPT male
Connection material:	316 Stainless
Max. working / test pressure (Bar g.):	6.0 / 9.0
Max. working temperature (Deg C.):	100

Heat Exchanger circuit - Side 2

Fluid description:	Water
Fluid flow rate (Kg/sec):	0.96
Inlet temperature (Deg C.):	62.0
Outlet temperature (Deg C.):	82.0
Pressure drop (Kpa):	6.6
Inlet / outlet locations:	F3 / F2
Connection size & type:	1.0" BSPT male
Connection material:	316 Stainless
Max. working / test pressure (Bar g.):	6.0 / 9.0
Max. working temperature (Deg C.):	100

Constructional Details

Channel Arrangement:	1 x 27 / 1 x 27
Plate material:	0.4 mm / 316 Stainless
Plate type:	Single wall
Gasket material:	Nitrile - clip in
Frame specification:	Steel - painted (2 Pack Acrylic)
Weight empty (Kgs):	58
Hold up volume (Litres):	11
Frame length - Dimension L (mm):	336

Plate Heat Exchanger Data Sheet

Model type: PHE100 (67 plates)

Heat transfer duty (kW): 100

Heat Exchanger circuit - Side 1

Fluid description:	Water
Fluid flow rate (Kg/sec):	1.19
Inlet temperature (Deg C.):	86.0
Outlet temperature (Deg C.):	66.0
Pressure drop (Kpa):	7.2
Inlet / outlet locations:	F1 / F4
Connection size & type:	1.0" BSPT male
Connection material:	316 Stainless
Max. working / test pressure (Bar g.):	6.0 / 9.0
Max. working temperature (Deg C.):	100

Heat Exchanger circuit - Side 2

Fluid description:	Water
Fluid flow rate (Kg/sec):	1.19
Inlet temperature (Deg C.):	62.0
Outlet temperature (Deg C.):	82.0
Pressure drop (Kpa):	7.2
Inlet / outlet locations:	F3 / F2
Connection size & type:	1.0" BSPT male
Connection material:	316 Stainless
Max. working / test pressure (Bar g.):	6.0 / 9.0
Max. working temperature (Deg C.):	100

Constructional Details

Channel Arrangement:	1 x 33 / 1 x 33
Plate material:	0.5 mm / 316 Stainless
Plate type:	Single wall
Gasket material:	Nitrile - clip in
Frame specification:	Steel - painted (2 Pack Acrylic)
Weight empty (Kgs):	63
Hold up volume (Litres):	14
Frame length - Dimension L (mm):	336

Plate Heat Exchanger Data Sheet

Model type: PHE120 (79 plates)

Heat transfer duty (kW): 120

Heat Exchanger circuit - Side 1

Fluid description:	Water
Fluid flow rate (Kg/sec):	1.43
Inlet temperature (Deg C.):	86.0
Outlet temperature (Deg C.):	66.0
Pressure drop (Kpa):	7.9
Inlet / outlet locations:	F1 / F4
Connection size & type:	1.0" BSPT male
Connection material:	316 Stainless
Max. working / test pressure (Bar g.):	6.0 / 9.0
Max. working temperature (Deg C.):	100

Heat Exchanger circuit - Side 2

Fluid description:	Water
Fluid flow rate (Kg/sec):	1.43
Inlet temperature (Deg C.):	62.0
Outlet temperature (Deg C.):	82.0
Pressure drop (Kpa):	7.8
Inlet / outlet locations:	F3 / F2
Connection size & type:	1.0" BSPT male
Connection material:	316 Stainless
Max. working / test pressure (Bar g.):	6.0 / 9.0
Max. working temperature (Deg C.):	100

Constructional Details

Channel Arrangement:	1 x 39 / 1 x 39
Plate material:	0.4 mm / 316 Stainless
Plate type:	Single wall
Gasket material:	Nitrile - clip in (2 Pack Acrylic)
Frame specification:	Steel - painted
Weight empty (Kgs):	72
Hold up volume (Litres):	16
Frame length - Dimension L (mm):	503

Plate Heat Exchanger Data Sheet

Model type: PHE150 (97 plates)

Heat transfer duty (kW): 150

Heat Exchanger circuit - Side 1

Fluid description:	Water
Fluid flow rate (Kg/sec):	1.79
Inlet temperature (Deg C.):	86.0
Outlet temperature (Deg C.):	66.0
Pressure drop (Kpa):	9.0
Inlet / outlet locations:	F1 / F4
Connection size & type:	1.0" BSPT male
Connection material:	316 Stainless
Max. working / test pressure (Bar g.):	6.0 / 9.0
Max. working temperature (Deg C.):	100

Heat Exchanger circuit - Side 2

Fluid description:	Water
Fluid flow rate (Kg/sec):	1.79
Inlet temperature (Deg C.):	62.0
Outlet temperature (Deg C.):	82.0
Pressure drop (Kpa):	8.9
Inlet / outlet locations:	F3 / F2
Connection size & type:	1.0" BSPT male
Connection material:	316 Stainless
Max. working / test pressure (Bar g.):	6.0 / 9.0
Max. working temperature (Deg C.):	100

Constructional Details

Channel Arrangement:	1 x 48 / 1 x 48
Plate material:	0.4 mm / 316 Stainless
Plate type:	Single wall
Gasket material:	Nitrile - clip in (2 Pack Acrylic)
Frame specification:	Steel - painted
Weight empty (Kgs):	79
Hold up volume (Litres):	20
Frame length - Dimension L (mm):	503

Plate Heat Exchanger Data Sheet

Model type: PHE160 (35 Plates)

Heat transfer duty (kW): 160

Heat Exchanger circuit - Side 1

Fluid description:	Water
Fluid flow rate (Kg/sec):	1.91
Inlet temperature (Deg C.):	86.0
Outlet temperature (Deg C.):	66.0
Pressure drop (Kpa):	9.8
Inlet / outlet locations:	F1 / F4
Connection size & type:	2.5" PN16 Flanged
Connection material:	Steel - Rubber lined
Max. working / test pressure (Bar g.):	6.0 / 9.0
Max. working temperature (Deg C.):	100

Heat Exchanger circuit - Side 2

Fluid description:	Water
Fluid flow rate (Kg/sec):	1.91
Inlet temperature (Deg C.):	62.0
Outlet temperature (Deg C.):	82.0
Pressure drop (Kpa):	9.8
Inlet / outlet locations:	F3 / F2
Connection size & type:	2.5" PN16 Flanged
Connection material:	Steel - Rubber lined
Max. working / test pressure (Bar g.):	6.0 / 9.0
Max. working temperature (Deg C.):	100

Constructional Details

Channel Arrangement:	1 x 17 / 1 x 17
Plate material:	0.4 mm / 304 Stainless
Plate type:	Single wall
Gasket material:	Nitrile - clip in
Frame specification:	Painted Steel (2 Pack Acrylic)
Weight empty (Kgs):	206
Hold up volume (Litres):	20
Frame length - Dimension L (mm):	442

Plate Heat Exchanger Data Sheet

Model type: PHE180 (39 plates)

Heat transfer duty (kW): 180

Heat Exchanger circuit - Side 1

Fluid description:	Water
Fluid flow rate (Kg/sec):	2.15
Inlet temperature (Deg C.):	86.0
Outlet temperature (Deg C.):	66.0
Pressure drop (Kpa):	9.9
Inlet / outlet locations:	F1 / F4
Connection size & type:	2.5" PN16 Flanged
Connection material:	Steel - Rubber Lined
Max. working / test pressure (Bar g.):	6.0 / 9.0
Max. working temperature (Deg C.):	100

Heat Exchanger circuit - Side 2

Fluid description:	Water
Fluid flow rate (Kg/sec):	2.15
Inlet temperature (Deg C.):	62.0
Outlet temperature (Deg C.):	82.0
Pressure drop (Kpa):	9.9
Inlet / outlet locations:	F3 / F2
Connection size & type:	2.5" PN16 Flanged
Connection material:	Steel - Rubber Lined
Max. working / test pressure (Bar g.):	6.0 / 9.0
Max. working temperature (Deg C.):	100

Constructional Details

Channel Arrangement:	1 x 19 / 1 x 19
Plate material:	0.4 mm / 304 Stainless
Plate type:	Single wall
Gasket material:	Nitrile - clip in
Frame specification:	Steel - painted (2 Pack Acrylic)
Weight empty (Kgs):	209
Hold up volume (Litres):	23
Frame length - Dimension L (mm):	442

Plate Heat Exchanger Data Sheet

Model type: PHE200 (41 plates)

Heat transfer duty (kW): 200

Heat Exchanger circuit - Side 1

Fluid description:	Water
Fluid flow rate (Kg/sec):	2.39
Inlet temperature (Deg C.):	86.0
Outlet temperature (Deg C.):	66.0
Pressure drop (Kpa):	11.0
Inlet / outlet locations:	F1 / F4
Connection size & type:	2.5" PN16 Flanged
Connection material:	Steel - rubber lined
Max. working / test pressure (Bar g.):	6.0 / 9.0
Max. working temperature (Deg C.):	100

Heat Exchanger circuit - Side 2

Fluid description:	Water
Fluid flow rate (Kg/sec):	2.39
Inlet temperature (Deg C.):	62.0
Outlet temperature (Deg C.):	82.0
Pressure drop (Kpa):	11.0
Inlet / outlet locations:	F3 / F2
Connection size & type:	2.5" PN16 Flanged
Connection material:	Steel - rubber lined
Max. working / test pressure (Bar g.):	6.0 / 9.0
Max. working temperature (Deg C.):	100

Constructional Details

Channel Arrangement:	1 x 20 / 1 x 20
Plate material:	0.4 mm / 304 Stainless
Plate type:	Single wall
Gasket material:	Nitrile - clip in
Frame specification:	Steel - painted (2 Pack Acrylic)
Weight empty (Kgs):	211
Hold up volume (Litres):	24
Frame length - Dimension L (mm):	442

Plate Heat Exchanger Data Sheet

Model type: PHE240 (47 plates)

Heat transfer duty (kW): 240

Heat Exchanger circuit - Side 1

Fluid description:	Water
Fluid flow rate (Kg/sec):	2.86
Inlet temperature (Deg C.):	86.0
Outlet temperature (Deg C.):	66.0
Pressure drop (Kpa):	12.0
Inlet / outlet locations:	F1 / F4
Connection size & type:	2.5" PN16 Flanged
Connection material:	Steel - rubber lined
Max. working / test pressure (Bar g.):	6.0 / 9.0
Max. working temperature (Deg C.):	100

Heat Exchanger circuit - Side 2

Fluid description:	Water
Fluid flow rate (Kg/sec):	2.87
Inlet temperature (Deg C.):	62.0
Outlet temperature (Deg C.):	82.0
Pressure drop (Kpa):	15.0
Inlet / outlet locations:	F3 / F2
Connection size & type:	2.5" PN16 Flanged
Connection material:	Steel - rubber lined
Max. working / test pressure (Bar g.):	6.0 / 9.0
Max. working temperature (Deg C.):	100

Constructional Details

Channel Arrangement:	1 x 23 / 1 x 23
Plate material:	0.4 mm / 304 Stainless
Plate type:	Single wall
Gasket material:	Nitrile - clip in
Frame specification:	Steel - painted (2 Pack Acrylic)
Weight empty (Kgs):	216
Hold up volume (Litres):	28
Frame length - Dimension L (mm):	442

Plate Heat Exchanger Data Sheet

Model type: PHE300 (57 plates)

Heat transfer duty (kW): 300

Heat Exchanger circuit - Side 1

Fluid description:	Water
Fluid flow rate (Kg/sec):	3.58
Inlet temperature (Deg C.):	86.0
Outlet temperature (Deg C.):	66.0
Pressure drop (Kpa):	12.8
Inlet / outlet locations:	F1 / F4
Connection size & type:	2.5" PN16 Flanged
Connection material:	Steel - rubber lined
Max. working / test pressure (Bar g.):	6.0 / 9.0
Max. working temperature (Deg C.):	100

Heat Exchanger circuit - Side 2

Fluid description:	Water
Fluid flow rate (Kg/sec):	3.58
Inlet temperature (Deg C.):	62.0
Outlet temperature (Deg C.):	82.0
Pressure drop (Kpa):	12.8
Inlet / outlet locations:	F3 / F2
Connection size & type:	2.5" PN16 Flanged
Connection material:	Steel - rubber lined
Max. working / test pressure (Bar g.):	6.0 / 9.0
Max. working temperature (Deg C.):	100

Constructional Details

Channel Arrangement:	1 x 28 / 1 x 28
Plate material:	0.4 mm / 304 Stainless
Plate type:	Single wall
Gasket material:	Nitrile - clip in
Frame specification:	Steel - painted (2 Pack Acrylic)
Weight empty (Kgs):	244
Hold up volume (Litres):	34
Frame length - Dimension L (mm):	442

Plate Heat Exchanger Data Sheet

Model type: PHE360 (67 plates)

Heat transfer duty (kW): 360

Heat Exchanger circuit - Side 1

Fluid description:	Water
Fluid flow rate (Kg/sec):	4.29
Inlet temperature (Deg C.):	86.0
Outlet temperature (Deg C.):	66.0
Pressure drop (Kpa):	13.5
Inlet / outlet locations:	F1 / F4
Connection size & type:	2.5" PN16 Flanged
Connection material:	Steel - rubber lined
Max. working / test pressure (Bar g.):	6.0 / 9.0
Max. working temperature (Deg C.):	100

Heat Exchanger circuit - Side 2

Fluid description:	Water
Fluid flow rate (Kg/sec):	4.30
Inlet temperature (Deg C.):	62.0
Outlet temperature (Deg C.):	82.0
Pressure drop (Kpa):	16.3
Inlet / outlet locations:	F3 / F2
Connection size & type:	2.5" PN16 Flanged
Connection material:	Steel - rubber lined
Max. working / test pressure (Bar g.):	6.0 / 9.0
Max. working temperature (Deg C.):	100

Constructional Details

Channel Arrangement:	1 x 33 / 1 x 33
Plate material:	0.4 mm / 304 Stainless
Plate type:	Single wall
Gasket material:	Nitrile - clip in
Frame specification:	Steel - painted (2 Pack Acrylic)
Weight empty (Kgs):	235
Hold up volume (Litres):	40
Frame length - Dimension L (mm):	542

Plate Heat Exchanger Data Sheet

Model type: PHE400 (73 plates)

Heat transfer duty (kW): 400

Heat Exchanger circuit - Side 1

Fluid description:	Water
Fluid flow rate (Kg/sec):	4.78
Inlet temperature (Deg C.):	86.0
Outlet temperature (Deg C.):	66.0
Pressure drop (Kpa):	14.1
Inlet / outlet locations:	F1 / F4
Connection size & type:	2.5" PN16 flanged
Connection material:	Steel - rubber lined
Max. working / test pressure (Bar g.):	6.0 / 9.0
Max. working temperature (Deg C.):	100

Heat Exchanger circuit - Side 2

Fluid description:	Water
Fluid flow rate (Kg/sec):	4.78
Inlet temperature (Deg C.):	62.0
Outlet temperature (Deg C.):	82.0
Pressure drop (Kpa):	14.1
Inlet / outlet locations:	F3 / F2
Connection size & type:	2.5" PN16 flanged
Connection material:	Steel - rubber lined
Max. working / test pressure (Bar g.):	6.0 / 9.0
Max. working temperature (Deg C.):	100

Constructional Details

Channel Arrangement:	1 x 36 / 1 x 36
Plate material:	0.4 mm / 304 Stainless
Plate type:	Single wall
Gasket material:	Nitrile - clip in
Frame specification:	Steel - painted (2 Pack Acrylic)
Weight empty (Kgs):	240
Hold up volume (Litres):	43
Frame length - Dimension L (mm):	542

Plate Heat Exchanger Data Sheet

Model type: PHE450 (81 plates)

Heat transfer duty (kW): 450

Heat Exchanger circuit - Side 1

Fluid description:	Water
Fluid flow rate (Kg/sec):	5.37
Inlet temperature (Deg C.):	86.0
Outlet temperature (Deg C.):	66.0
Pressure drop (Kpa):	14.7
Inlet / outlet locations:	F1 / F4
Connection size & type:	2.5" PN16 flanged
Connection material:	Steel - rubber lined
Max. working / test pressure (Bar g.):	6.0 / 9.0
Max. working temperature (Deg C.):	100

Heat Exchanger circuit - Side 2

Fluid description:	Water
Fluid flow rate (Kg/sec):	5.37
Inlet temperature (Deg C.):	62.0
Outlet temperature (Deg C.):	82.0
Pressure drop (Kpa):	14.7
Inlet / outlet locations:	F3 / F2
Connection size & type:	2.5" PN16 flanged
Connection material:	Steel - rubber lined
Max. working / test pressure (Bar g.):	6.0 / 9.0
Max. working temperature (Deg C.):	100

Constructional Details

Channel Arrangement:	1 x 40 / 1 x 40
Plate material:	0.4 mm / 304 Stainless
Plate type:	Single wall
Gasket material:	Nitrile - clip in
Frame specification:	Steel - painted (2 Pack Acrylic)
Weight empty (Kgs):	249
Hold up volume (Litres):	48
Frame length - Dimension L (mm):	642

Plate Heat Exchanger Data Sheet

Model type: PHE480 (85 plates)

Heat transfer duty (kW): 480

Heat Exchanger circuit - Side 1

Fluid description:	Water
Fluid flow rate (Kg/sec):	5.73
Inlet temperature (Deg C.):	86.0
Outlet temperature (Deg C.):	66.0
Pressure drop (Kpa):	15.3
Inlet / outlet locations:	F1 / F4
Connection size & type:	2.5" PN16 flanged
Connection material:	Steel - rubber lined
Max. working / test pressure (Bar g.):	6.0 / 9.0
Max. working temperature (Deg C.):	100

Heat Exchanger circuit - Side 2

Fluid description:	Water
Fluid flow rate (Kg/sec):	5.73
Inlet temperature (Deg C.):	62.0
Outlet temperature (Deg C.):	82.0
Pressure drop (Kpa):	15.2
Inlet / outlet locations:	F3 / F2
Connection size & type:	2.5" PN16 flanged
Connection material:	Steel - rubber lined
Max. working / test pressure (Bar g.):	6.0 / 9.0
Max. working temperature (Deg C.):	100

Constructional Details

Channel Arrangement:	1 x 42 / 1 x 42
Plate material:	0.4 mm / 304 Stainless
Plate type:	Single wall
Gasket material:	Nitrile - clip in
Frame specification:	Steel - painted (2 Pack Acrylic)
Weight empty (Kgs):	252
Hold up volume (Litres):	50
Frame length - Dimension L (mm):	642

Plate Heat Exchanger Data Sheet

Model type: PHE500 (89 plates)

Heat transfer duty (kW): 500

Heat Exchanger circuit - Side 1

Fluid description:	Water
Fluid flow rate (Kg/sec):	5.96
Inlet temperature (Deg C.):	86.0
Outlet temperature (Deg C.):	66.0
Pressure drop (Kpa):	15.3
Inlet / outlet locations:	F1 / F4
Connection size & type:	2.5" PN16 flanged
Connection material:	Steel - rubber lined
Max. working / test pressure (Bar g.):	6.0 / 9.0
Max. working temperature (Deg C.):	100

Heat Exchanger circuit - Side 2

Fluid description:	Water
Fluid flow rate (Kg/sec):	5.97
Inlet temperature (Deg C.):	62.0
Outlet temperature (Deg C.):	82.0
Pressure drop (Kpa):	15.2
Inlet / outlet locations:	F3 / F2
Connection size & type:	2.5" PN16 flanged
Connection material:	Steel - rubber lined
Max. working / test pressure (Bar g.):	6.0 / 9.0
Max. working temperature (Deg C.):	100

Constructional Details

Channel Arrangement:	1 x 44 / 1 x 44
Plate material:	0.4 mm / 304 Stainless
Plate type:	Single wall
Gasket material:	Nitrile - clip in
Frame specification:	Steel - painted (2 Pack Acrylic)
Weight empty (Kgs):	256
Hold up volume (Litres):	53
Frame length - Dimension L (mm):	642

Plate Heat Exchanger Data Sheet

Model type: PHE540 (95 plates)

Heat transfer duty (kW): 540

Heat Exchanger circuit - Side 1

Fluid description:	Water
Fluid flow rate (Kg/sec):	6.44
Inlet temperature (Deg C.):	86.0
Outlet temperature (Deg C.):	66.0
Pressure drop (Kpa):	15.9
Inlet / outlet locations:	F1 / F4
Connection size & type:	2.5" PN16 flanged
Connection material:	Steel - rubber lined
Max. working / test pressure (Bar g.):	6.0 / 9.0
Max. working temperature (Deg C.):	100

Heat Exchanger circuit - Side 2

Fluid description:	Water
Fluid flow rate (Kg/sec):	6.45
Inlet temperature (Deg C.):	62.0
Outlet temperature (Deg C.):	82.0
Pressure drop (Kpa):	15.8
Inlet / outlet locations:	F3 / F2
Connection size & type:	2.5" PN16 flanged
Connection material:	Steel - rubber lined
Max. working / test pressure (Bar g.):	6.0 / 9.0
Max. working temperature (Deg C.):	100

Constructional Details

Channel Arrangement:	1 x 47 / 1 x 47
Plate material:	0.4 mm / 304 Stainless
Plate type:	Single wall
Gasket material:	Nitrile - clip in
Frame specification:	Steel - painted (2 Pack Acrylic)
Weight empty (Kgs):	261
Hold up volume (Litres):	56
Frame length - Dimension L (mm):	642

Plate Heat Exchanger Data Sheet

Model type: PHE600 (105 plates)

Heat transfer duty (kW): 600

Heat Exchanger circuit - Side 1

Fluid description:	Water
Fluid flow rate (Kg/sec):	7.16
Inlet temperature (Deg C.):	86.0
Outlet temperature (Deg C.):	66.0
Pressure drop (Kpa):	16.4
Inlet / outlet locations:	F1 / F4
Connection size & type:	2.5" PN16 flanged
Connection material:	Steel - rubber lined
Max. working / test pressure (Bar g.):	6.0 / 9.0
Max. working temperature (Deg C.):	100

Heat Exchanger circuit - Side 2

Fluid description:	Water
Fluid flow rate (Kg/sec):	7.16
Inlet temperature (Deg C.):	62.0
Outlet temperature (Deg C.):	82.0
Pressure drop (Kpa):	16.4
Inlet / outlet locations:	F3 / F2
Connection size & type:	2.5" PN16 flanged
Connection material:	Steel - rubber lined
Max. working / test pressure (Bar g.):	6.0 / 9.0
Max. working temperature (Deg C.):	100

Constructional Details

Channel Arrangement:	1 x 52 / 1 x 52
Plate material:	0.4 mm / 304 Stainless
Plate type:	Single wall
Gasket material:	Nitrile - clip in
Frame specification:	Steel - painted (2 Pack Acrylic)
Weight empty (Kgs):	279
Hold up volume (Litres):	62
Frame length - Dimension L (mm):	1042

Plate Heat Exchanger Data Sheet

Model type: PHE720 (127 plates)

Heat transfer duty (kW): 720

Heat Exchanger circuit - Side 1

Fluid description:	Water
Fluid flow rate (Kg/sec):	8.6
Inlet temperature (Deg C.):	86.0
Outlet temperature (Deg C.):	66.0
Pressure drop (Kpa):	17.3
Inlet / outlet locations:	F1 / F4
Connection size & type:	2.5" PN16 flanged
Connection material:	Steel - rubber lined
Max. working / test pressure (Bar g.):	6.0 / 9.0
Max. working temperature (Deg C.):	100

Heat Exchanger circuit - Side 2

Fluid description:	Water
Fluid flow rate (Kg/sec):	8.6
Inlet temperature (Deg C.):	62.0
Outlet temperature (Deg C.):	82.0
Pressure drop (Kpa):	17.2
Inlet / outlet locations:	F3 / F2
Connection size & type:	2.5" PN16 flanged
Connection material:	Steel - rubber lined
Max. working / test pressure (Bar g.):	6.0 / 9.0
Max. working temperature (Deg C.):	100

Constructional Details

Channel Arrangement:	1 x 63 / 1 x 63
Plate material:	0.4 mm / 304 Stainless
Plate type:	Single wall
Gasket material:	Nitrile - clip in
Frame specification:	Steel - painted (2 Pack Acrylic)
Weight empty (Kgs):	298
Hold up volume (Litres):	76
Frame length - Dimension L (mm):	1042

Strebel PHE Plate Heat Exchangers

Installation, Operating & Maintenance

Strebel Ltd

1F Albany Park Industrial Estate
Frimley Road, Camberley,
Surrey, GU16 7PB

Tel: 01276 685 422
Fax: 01276 685 405
Web: www.strebel.co.uk
Email: info@strebel.co.uk

1. Index

Section	Heading	Section	Heading
2	Installation	8	Gasket types
3	Start up	9	Assembly
4	Shut down	10	Tightening
5	Opening	11	Trouble shooting
6	Plate cleaning	12	Maintenance
7	Plate types	13	Spare parts

2. Installation - General Points

Lifting:

- **Exercise extreme caution at all times when lifting**
- Lift from underneath if on a base (pallet).
- Lift from lifting lugs when fitted – these are in the head frame plate – lift off the base, being careful to support the rear leg when the angle approaches 45 degrees as it shall fall backwards after this point.
- Block between the follower plate and the frame bars to prevent the follower plate from moving up or downwards.
- Lift from the top frame bar (close to the head/fixed frame plate, and support leg).
- Lift from the tie bolts (in-between the frame plates, close to head frame plate).

Avoid:

- Lifting from the connections.
- Lifting from the follower / mobile frame plate unless wedges are blocked between the frame plate and the frame bars to prevent the plate from moving upwards.
- Lifting from the intermediate frame plates.
- Lifting from the tie bolts near to, and after, the follower / mobile frame plate.

Space:

- Leave a minimum of double the width of the exchanger, either side of the unit, to allow for access to the bolts and for the easy removal of the heat transfer plates.

Leakage:

- Gasketed plate heat exchangers have the potential to leak. Therefore to avoid damage to plant room floor, electrical conduits, etc., we recommend that a drip tray be placed underneath the plate pack.

Pipe work: We recommend the following

1. that the pipe work is fully supported to avoid weight/forces acting upon the unit.
2. the fitting of flexible couplings if the pipe work is subject to vibration.
3. the fitting of flexible couplings if operating over 80 Deg. C. (to absorb expansion).
4. that the pipe work is completely flushed before attaching to exchanger.
5. the fitting of de-mountable elbow bends onto connections located on follower frame plate - this allows the follower plate to be pushed back fully along the frame bars – also, it allows the plate pack to be tightened further if necessary/possible without straining the connections.

Welding:

- If pipe work is to be welded near to the exchanger, then do not use the unit as a grounding mechanism.
- Electric arcs can occur between the plates, which will damage both the plate material and the gaskets.
- Isolate the exchanger before any welding is carried out.

Filtration:

- Remove particles greater than 1.0 m.m. diameter (unless otherwise stated).

Connections:

- Use two wrenches when attaching unions to threaded stub connections. One to tighten the union, & the other to prevent the stub end from rotating (avoids damage to gasket inside the unit which seals against the back on the stub connection).
- Use a non-hardening thread sealant for best results when attaching screwed unions, etc.

Strebel Ltd

1F Albany Park Industrial Estate
 Frimley Road, Camberley,
 Surrey, GU16 7PB

Tel: 01276 685 422
 Fax: 01276 685 405
 Web: www.strebel.co.uk
 Email: info@strebel.co.uk

- Flanged connections - If the connection nozzle hole is rubber lined, the liner will act as the flange gasket. Bolt the connecting flange directly to the endplate using the drilled & tapped holes provided. Tighten bolts evenly - do not over-tighten as this could strip the threads cut into the frame plate.
- If stand-off, or loose backing flanges are fitted to the exchanger, a suitable gasket is required to seal the flange.
- Unless otherwise stated, the liquid circuits should be connected to flow in reverse directions through the exchanger (counter-current). Refer to Contract drawing, or quotation details, if the connections are not marked. See Fig. 1 for nozzle designation.

Safety:

- If the unit is to operate above 60 Deg. C., or if it contains corrosive media, then consideration needs to be given to protecting nearby personnel. We recommend the fitting of protective screens / shields over the plate pack.
- Insulate hot surfaces as necessary.
- Pressure relief valves – these should be fitted into both circuits
- Steam units – it is good practice to fit vacuum gauges into the steam pipe work – consult a steam specialist for advise on selection and fitting of these devices.
- Vents and drains – suitable sized and located valves need to be installed to allow adequate venting and draining of the exchanger – locate vents and drains into the connecting pipe work as close to the exchanger as possible.

3. Commissioning & Starting**Safety:**

- Before starting, ensure that all safety checks have been made and that all protective screens and safety devices are in place and fitted correctly.
- Check that the maximum working pressure and temperature of the system do not exceed the values stated on the exchanger name plate or the design specification.
- Check that the liquids that are intended to be passed through the exchanger are all as per the design specification, and that they are suitable for the all wetted parts of the exchanger.

Shock:

- It is essential that the exchanger is not subjected to thermal or mechanical shock.

Start up:

- Fully vent system & then close vent valves.
- Close isolation valves between pump & exchanger.
- Fully open valve fitted into return line from the exchanger.
- Start the circulation pump.
- **Gradually** open closed valve fitted to inlet line of exchanger.
- Vent circuit again if necessary.
- Repeat for other circuit(s).

Checks:

- Check system pressure and temperatures do not exceed exchanger design specification
- Check for leaks, pressure pulses, and ensure that all pump and air vents are closed.

Steam:

Use only slow acting control valves and mechanisms.

Before start up : A) ensure that the steam control valve is fully closed.
 B) ensure that the exchanger is fully drained of condensate.

- Start cold circuit first, then the steam side.
- Open steam control valve slowly - this prevents water hammer of any condensate in the steam line, and reduces the pressure / thermal shock to the exchanger.
- Ensure that the steam trap is correctly sized to allow full condensate discharge - this prevents water clogging inside the exchanger.

Strebel Ltd

1F Albany Park Industrial Estate
Frimley Road, Camberley,
Surrey, GU16 7PB

Tel: 01276 685 422
Fax: 01276 685 405
Web: www.strebel.co.uk
Email: info@strebel.co.uk

4. Shutting down the Exchanger

Warning *Water hammer & thermal shock can damage the exchanger resulting in loss of fluid from one, or more, of the liquid circuits.*

Water hammer occurs when a flowing liquid is suddenly halted. Pressure waves then travel along the pipes creating a hammering effect as they bounce off any restrictions within the pathway.

Thermal shock occurs when the bulk temperature of the exchanger is suddenly raised or lowered. The resulting expansion or contraction of the unit can result in leakage - sometimes quite severe from the plate pack.

Both water hammer & thermal shock can be avoided by not using fast acting control valves, therefore, sufficient consideration should be given to protecting the heat exchanger when designing the associated control systems.

Shut down:

- SLOWLY close the control valve on the "hot" circuit whilst maintaining the full flow on the "cold" circuit.
- Switch off hot circuit pump.
- SLOWLY close the control valve on the cold circuit.
- Switch off the cold circuit pump.
- Close all isolating valves.

Storage:

If the unit is to be taken off line for an extended period of time, then the following procedure can be followed:

- Allow unit to cool and drain all circuits
- Lubricate tie bolts.
- Loosen tie bolts until the plate pack is "relaxed". The tie bolts should not be removed or loosened to such an extent that dirt is allowed to enter in-between the plates.
- Attach warning label to advise personnel not to use exchanger in this partially opened condition
- Cover the plate pack with black plastic to exclude any sun light.

5. Opening the Heat Exchanger

Tools: Good quality friction/ratchet spanners and ring or open ended spanners, plus light machine oil.

Safety: Wear gloves – the edges of the plates are sharp. Other protective gear may be necessary depending upon the types of fluids in the exchanger (such as face and gas masks for ammonia exchangers).

Procedure:

- Allow unit to cool, and clean off tops of plates (use brush or air line).
- Release all pressure from inside of exchanger by venting and draining in a safe manner according to the fluids that are contained within the exchanger.
- If fitted, remove the pipe work connected to follower frame plate, & the intermediate frame plates.
- Lightly oil tie bolt threads, and along top of frame carrier bar (upper most frame bar).
- Undo the clamping bolts uniformly - keep the frame plates as parallel as possible during this operation.
- Push / pull back the mobile frame plate away from plates pack & secure if necessary.
- Separate heat transfer plates carefully, avoiding damage to gaskets.

WARNING – on some frame models the heat transfer plates are supported by the lower frame bar as opposed to being "hung" from the top frame bar (DN100 – 4" connection frames in particular). The plates can fall back when the follower frame plate is moved – take extreme caution when pulling back the follower plate on IG frame models. (This warning does not apply to any other frame types).

Suggested bolt loosening sequence :- See Fig. 2

FIG. 1 : NOZZLE DESIGNATION

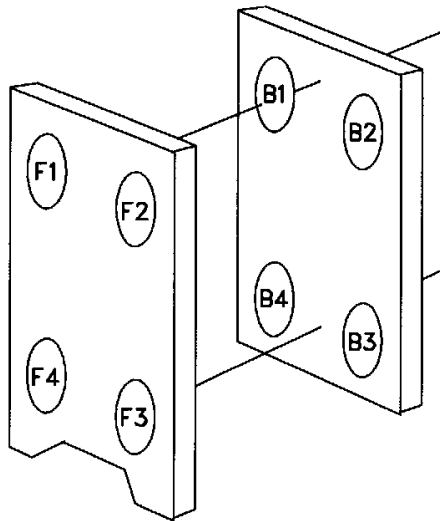
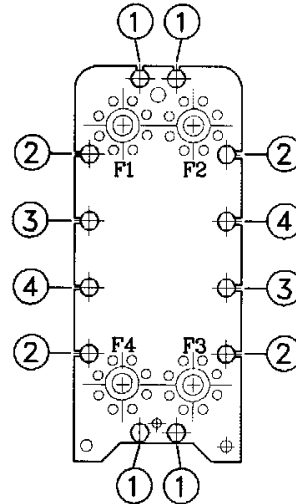
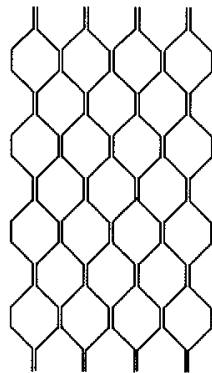
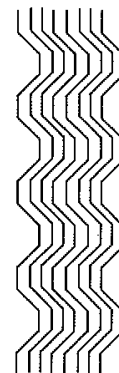

FIG. 2 : BOLT LOOSENING SEQUENCE

 FIG. 5 :-
 EXAMPLE OF THE
 PLATE HONEYCOMBE
 PATTERN.

CORRECT



WRONG !

FIG. 6 : TIGHTENING DIMENSION

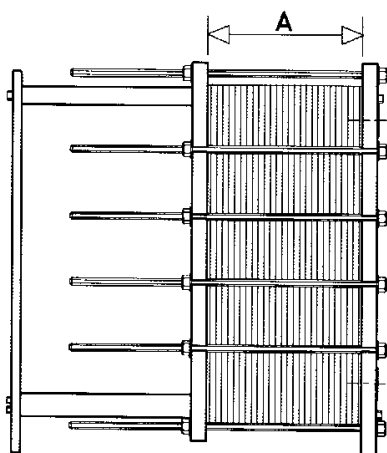

FIG. 7 : TIGHTENING SEQUENCE

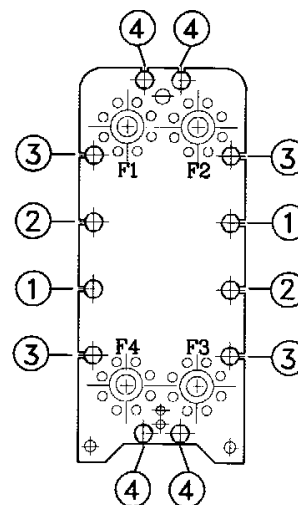

FIG. 4 : GASKET TYPES



 NORMAL / FULL
 GASKET.

 START PLATE GASKET
 MADE UP OF 2 FULL
 GASKETS, CUT IN HALF.

 START PLATE GASKET
 WITH SEPARATE O-RINGS.

FIG. 3 : PLATE TYPES

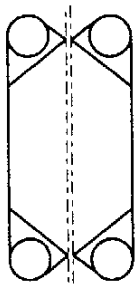
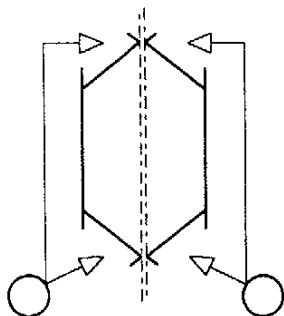
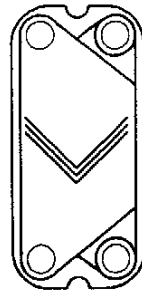
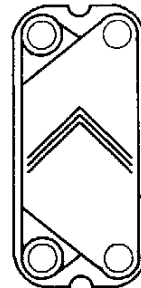
 LEFT HAND
 FLOW PLATE

 RIGHT HAND
 FLOW PLATE

GASKET



1234



1200



0034

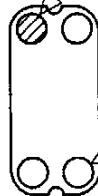

0234

BLANKED PORT HOLE

OPEN PORT HOLE



1004



0230



0004

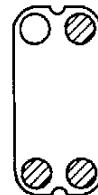

1000

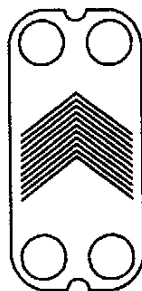

THERMAL LONG



THERMAL SHORT

6. Cleaning of the plates

Safety: Wear gloves & eye goggles when using cleaning detergents.

Brushing: Use nylon or other types of "soft" scrubbing brushes with detergent. **Never** use a metal brush, steel wool, or sand/glass paper.

Gasket glue: Removal – use Acetone. Alternatively, use an LP gas flame, heating the reverse side of the plate. Do not use any other type of gas which may produce a "harder" flame. A tank of boiling water can be used to soften the glue.

Detergents: Consult a cleaning specialist for a suitable choice of detergent. Ensure that all detergents used are compatible with the plate and gasket material before use.

- **Oxide or chalk** deposits - use 2 to 5% nitric acid solution.
- **Organic, protein containing** deposits - use 2% solution of sodium hydroxide at temperature of 50 deg. C.
- **Grease** deposits - use neat kerosene, or an emulsifying agent (Jizer or Gunk).
- **Lime** deposits - 10% nitric acid soak at room temperature for 10 minutes, followed by a caustic soda wash.

C.I.P.:

If the solution requires recirculation, select a flow that is as high as possible, and certainly no less than the service or product flows.

Follow the instructions as given by the detergent supplier / cleaning specialist. We suggest that for recirculated cleaning detergent methods, the fluid should be pumped through the exchanger for no less than 30 minutes.

Milk deposits - circulate 1.5% nitric acid at 65 deg. C. (2.4 litres of 62% HNO in 100 litres of water)

Organic or grease deposits - circulate 1.5% sodium hydroxide (NaOH) at 85 deg. C. (5 litres of 30% NAOH in 100 litres of water)

Rinsing:

After using any type of cleaning agent, always rinse thoroughly with fresh water. If cleaning in place, then circulate fresh water for at least 10 mins.

7. Plate types:

Each plate is identified by the gasket arrangement, the number of port holes open, and the angle of the pressing.

Example plate code:- L1234 Long

L = Left hand flow (No gasket O-rings around port holes on the left hand side of the plate).
 1234 = All port holes open
 Long = Thermal length of the plate (angle of the pressing).

See the Fig 3. for further examples of plate types.

A left handed plate and a right handed plate are effectively the same, except, one is rotated 180 degrees to the other.

The plates are always arranged in the pack so that they alternate between left & right handed plates.

If any of the plates become damaged, these can be removed, however, in order to respect the alternate handed plate rule, if a damaged plate is to be removed and not replaced, then the next plate in the pack must also be taken out (this shall be opposite handed to the damaged plate).

8. Gaskets:

See Fig. 4 for gasket types.

O-rings:

Where these are fitted, the flat side of the gasket is fitted into the circular gasket groove. If the O-ring is not flat on one side, then the thinnest part / side of the ring should be located into the gasket groove. It may be necessary to apply a small amount of gasket glue, or "Loctite" to hold the O-ring in place whilst the plate pack is being assembled.

Plate gaskets:

If the gaskets are to be replaced, ensure that the same plate port holes remain "open" as with the old gasket. If a number of gaskets are to be replaced, and the plates have been cleaned so the outline of the old gasket has been removed, then before attaching the gaskets, stack the plates with all of the pressing / herringbone patterns face in the same direction - the "arrow heads" facing towards you. Fix all gaskets to the plates so that the two port holes on the right hand side of the plate are surrounded by the gasket O-rings.

Adhesive:

Chlorine free glues only, such as Pliobond 20 or 30, Bostic 1782, 3M EC 1099, Scotchgrip 847, and Bond Spray 77.

Use adhesive in a well ventilated area and wear gloves to prevent skin contact with the glue.

If no instructions are provided by the adhesive manufacturer, then we suggest that a thin layer of glue is spread into the plate gasket groove, using either a narrow paint brush or a syringe. Contact adhesives (such as Pliobond 20 or 30) also require a thin layer of adhesive to be applied to the flat faced side of the gasket. Check that, once stuck, the gasket will be correctly positioned, then fix the gasket to the plates, ensuring that all parts are seated into the gasket grooves, with no parts of the gasket stretched or "bunched".

Stack the plates, and leave to set. Warm oven curing accelerates the drying process.

Snap in types:

These require no adhesive - they are located by pushing the gasket fully down into the gasket groove, or by pushing the gasket lugs through holes in the plate (depending on type)- some of the lugs may need to be pulled through by using thin nose pliers to ensure correct seating.

Rubber liners:

The rubber frame plate nozzle liners have an O-ring moulded into the liner itself. This moulded O-ring fits into the gasket groove in the first heat transfer plate. Therefore, if new gaskets have been fitted, the O-ring portion of the plate gasket around the plate port holes shall have to be cut off and removed prior to assembly back into the frame. The start plate gasket then shall look like the lowest diagram in **FIG. 4**.

Start plate:

These are usually made up of 2 flow plate gaskets cut lengthways in half (See FIG 4). They are usually glued into place – even if the other plates are adhesive free. Ensure that when preparing the start plate gasket, all lugs and webbing are cut off to allow the start plate to sit flat against the back of the frame plate. Units with rubber lined ports require the O-ring portion to be removed from the start plate gasket – see note above.

9. Plate Pack Assembly:

Safety:

Wear gloves – the edges of the plates are sharp.

Plates:

These must be clean, dry, and free from oil or grease. If there are any oil deposits on the gaskets, or on the gasket seating area, then there is a strong likelihood that the plates shall slip out of place when the unit is being tightened. If the gaskets are contaminated with dirt, or grit, then these could cause leakage.

Strebel Ltd

1F Albany Park Industrial Estate
Frimley Road, Camberley,
Surrey, GU16 7PB

Tel: 01276 685 422
Fax: 01276 685 405
Web: www.strebel.co.uk
Email: info@strebel.co.uk

Assembly:

- Fit O-rings first (if applicable).
- Refer to the Plate Sequence Sheet to determine the order of the plates, & the type required.
- Fit the start plate (see Plate Type Diagram), ensuring the plate pattern is pointing in the correct direction. If rubber liners fitted into the head frame plate then check to see that the O-ring portion of the plate gasket around the port holes which locate against the liner have been removed.
- Fit plates according to the Plate Sequence Sheet on some frames (not IS or FS type), it is sometimes necessary to ensure that the plates do not fall backwards during pack assembly operation.
- Ensure all gaskets face towards the fixed / head frame plate (unless stated other wise in the Plate Sequence Diagram).
- Alternate between left & right handed plates - if the plate edges form a regular honeycomb pattern, then the left / right hand sequence is correct (see Fig. 5).
- Check that all plates are hanging correctly – knock down on the top of the plates gently if some are out of line.

10. Tightening of the plate pack:
Procedure:

- Lightly oil tie bolt threads. Do not allow oil or grease onto the gaskets or the gasket seating faces on the back of the plates. Wet or oil contaminated plates can become misaligned during tightening. In the event, dismantle, clean, and dry all areas in contact with the gaskets.
- Evenly tighten all bolts. We recommend the use of ratchet spanners.
- Ensure clamping is as uniform as possible, thus keeping the frames plates parallel throughout the operation. Avoid skewing the frame plates by more than 10 m.m.
- Check to ensure that no plates have lifted out of line.
- Tightening is complete when the distance between the inside faces of the two frame plates equals the "A" dimension as shown on the contract drawing.
- Finally check that all bolts are in tension, and clean any spilt oil off the frame plates.
- On completion, the unit can be pressure tested (at the working pressure only).

See Fig. 6 for "A" dimension example.

See Fig. 7 for suggested bolt tightening sequence.

Warning:

Do not tighten the plate pack less than the minimum tightening dimension as given on the contract drawing. Over compression will damage both plates & gaskets. Always check that the number of plates actually fitted is correct because the tightening dimension is calculated by use of the following equation:

$$\text{Tightening dimension} = \text{No. of plates} \times (\text{plate thickness} + \text{coefficient})$$

The coefficients vary depending on the model type. Contact the Sales Offices for the correct coefficient to use.

EPDM gaskets:

This material is harder than nitrile, therefore, has to be compressed for the first time gradually – otherwise, the plates can distort around the region surrounding the port holes. This only applies to plates with port holes of 100 mm and above, and a thickness of less than 0.6 mm.

Compression 1: minimum tightening dimension + 15% - leave for 2 hours

Compression 2: minimum tightening dimension + 7.5% - leave for 12 hours

Compression 3: tighten down to either maximum tightening dimension or alternatively the minimum.

Minimum tightening measure:

If not set at this measure in the first instance, then it is recommended that the pack is tightened down to this setting after approx. one month in operation, or after opening the pack without changing the gaskets.

Strebel Ltd

1F Albany Park Industrial Estate
 Frimley Road, Camberley,
 Surrey, GU16 7PB

Tel: 01276 685 422
 Fax: 01276 685 405
 Web: www.strebel.co.uk
 Email: info@strebel.co.uk

11. Trouble Shooting:

Assembly / Dismantling:

- | | | | |
|----|-------------------------------------|---|---------------------------------------------------------------------------------------------------------------------------------------|
| 1. | Nuts tight to turn on assembly | = | insufficient oil on threads |
| | Nuts tight to turn when dismantling | = | pressure still inside unit – isolate, drain & vent |
| 2. | Plates move out of alignment | = | remove plates & degrease, then dry. |
| | | = | inspect plate hanging system for damage. |
| 3. | Plates riding up during tightening | = | loosen pack, knock down, re-tighten with top of frame plate slightly in further than bottom. Even out when close to assembly measure. |

Excessive pressure drops:

- | | | | |
|----|---------------------------------|---|----------------------------------------------------------------------------------|
| 1. | Liquid flows higher than design | = | check & adjust |
| 2. | Plate channels blocked | = | back flush, C.I.P., or dismantle to clean. |
| 3. | Inaccurate measurement | = | check pressure gauge for accuracy |
| | | = | ensure measurement does not include any bend, valve/ Fitting, & pipe run losses. |
| 4. | Liquid temp. below design. | = | viscous media generate higher resistance to flow at lower temperatures. |
| 5. | Media used not as per design | = | the addition of glycol or other additives can increase the pressure drop. |

Leakage:

- | | | | |
|----|-------------------------|---|--------------------------------------------------------------------------------------------------------------------------------|
| 1. | Leakage near connection | = | check condition of nozzle liner (if fitted). |
| | | = | check condition of O-ring gaskets on first plate (O-ring can be damaged or pulled out of seat if connection has been rotated). |
| | | = | check the flange gasket (if fitted). |
| | | = | check the stub connection backing flange for splits |
| | | = | check the connection O-rings (if fitted) |
| 2. | cross contamination | = | check all plates for cracks and / or holes. |
| 3. | leakage from plate pack | = | check tightening dimension |
| | | = | check condition of the gaskets. |
| | | = | check that all gaskets are seated correctly. |

For nearly all leakage problems, it shall be necessary to dismantle the unit before any attempts to rectify the fault can be made. Mark the area(s) from where the leaks are occurring before taking apart the exchanger.

“Cold leakage”:

Caused by a sudden change in temperature. The sealing properties of certain elastomers are temporarily reduced when the temperature changes suddenly. No action is required as the gaskets should re-seal after the temperature has stabilised.

Gasket failures are generally a result of:

- 1) old age
- 2) excessive exposure to ozone
- 3) high operating temperature - above the temp. limit of the material.
- 4) exposure to pressure surges.
- 5) chemical attack
- 6) physical damage - resulting from poor assembly practise, or damage resulting from a misaligned plate (check the hanging system at the top of the plate for distortion).

Decrease in the performance:

1. plate surfaces require cleaning or de-scaling.
2. pumps or associated controls have failed.
3. plate channels blocked.
4. liquid flows not as per the design specification.
5. associated chiller / cooling tower / boiler under sized.
6. cooling water flow temperature to the exchanger is higher than design.
7. heating media temperature lower than design figures.
8. steam flow not sufficient - control valve malfunction.
9. steam trap broken or jammed - this can cause the unit to become filled with condensate.
10. plate pack has been assembly incorrectly.
11. unit running in co-current flow, instead of counter current - check with contract drawing and alter pipe work if necessary., and check direction of pump flows.
12. air lock has developed in the plate pack.

12. Maintenance:

Time interval: Once a year as a minimum.

Performance: check temperatures and flows against commissioning data.

Plate pack: check the tightening dimension, and look for any signs of leakage.

Nozzles: check general condition, and for any signs of leakage.

Frame: wipe clean all painted parts, and check surfaces for signs of damage - "touch up" if necessary.

Bolts & bars: check for rust, and clean. Lightly coat threaded parts with molybdenum grease, or a corrosion inhibitor (ensure that no grease, etc. falls onto the plate gaskets).

Rollers: if fitted to the follower frame plate, lubricate bearings with light machine oil.

13. Spare Parts:

To help identify the unit, it shall be necessary to quote the serial number as given on the nameplate.

Strebel Ltd

1F Albany Park Industrial Estate
Frimley Road, Camberley,
Surrey, GU16 7PB

Tel: 01276 685 422
Fax: 01276 685 405
Web: www.strebel.co.uk
Email: info@strebel.co.uk