

CASCADE PROGRAMMING

Installation & Maintenance Manual

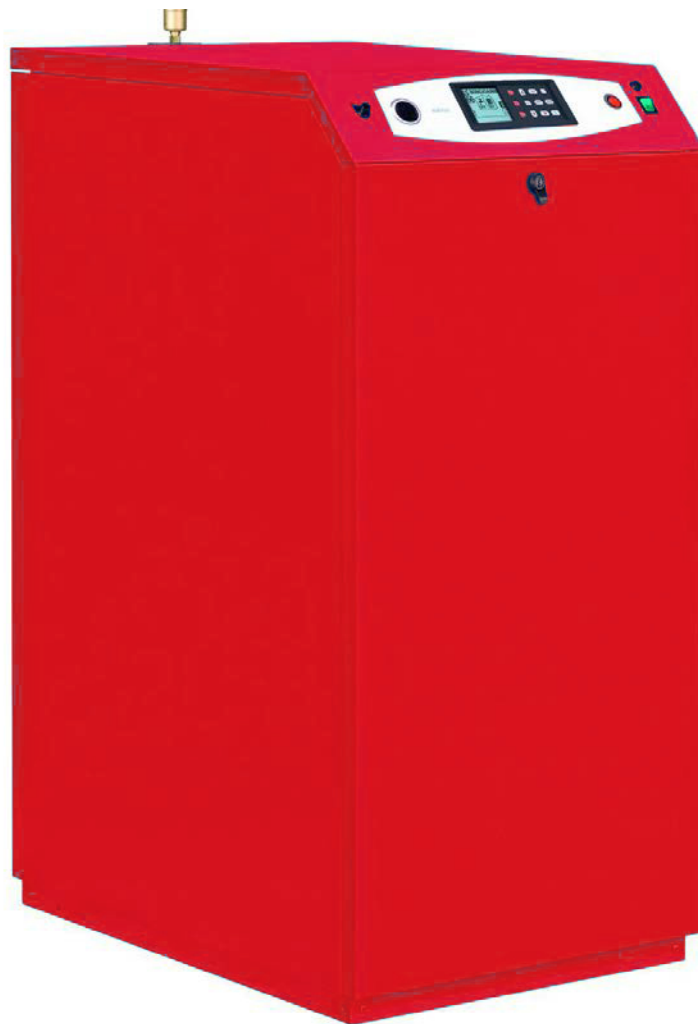

 **STREBEL**
HEATING TECHNOLOGY

2015-06-15 v1.0

GENERAL DESCRIPTION

The operating logic that enables the use of multiple generators (up to a maximum of 6) connected to one another is integrated in the control electronics on board each generator.

It is therefore sufficient to connect the various generators to one another using a suitable BUS cable in the cascade sequence and configure them accordingly

The operating logic envisages the allocation of a main generator, known as the MASTER, which will then control operation of all other subordinate generators, known as SLAVES

All "decisions" are taken by the MASTER generator and therefore all units required for cascade operation are connected to this generator, i.e. cascade pump, cascade sensor, room thermostat, outside sensor, and 0-10V input.

The "technical cascade menu programming" is carried out on the MASTER generator, which is connected to the storage tank thermostat/sensor when necessary.

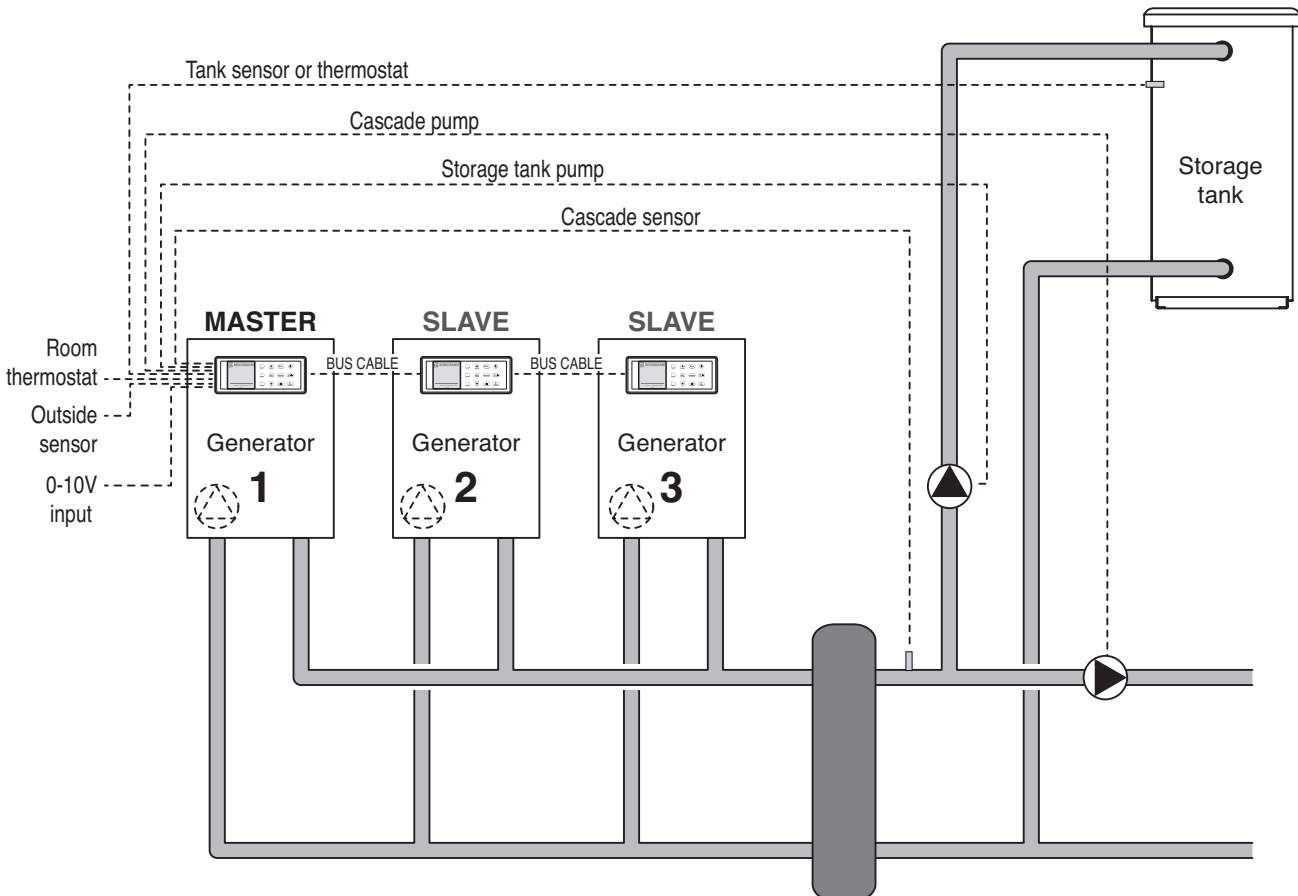

SERIAL CONNECTION OF GENERATORS PRESENT IN THE CASCADE SEQUENCE

The connection (BUS) that enables communication between the main boiler (MASTER) and subordinate boilers (SLAVE), present in the cascade sequence, is made as described below. The cable to be used must be 4-pole (Tx, Rx, GND and 5V).

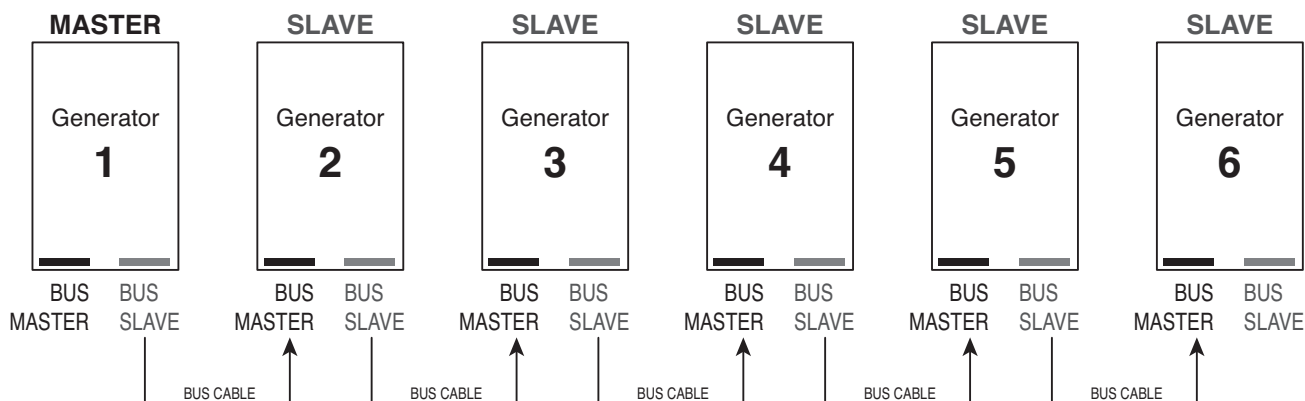

Where the connection to the “BUS MASTER” terminal board is not present (see generator 1) this means that the generator is the MASTER unit.

In the event of a fault, this type of connection enables simple exclusion of the malfunctioning generator.

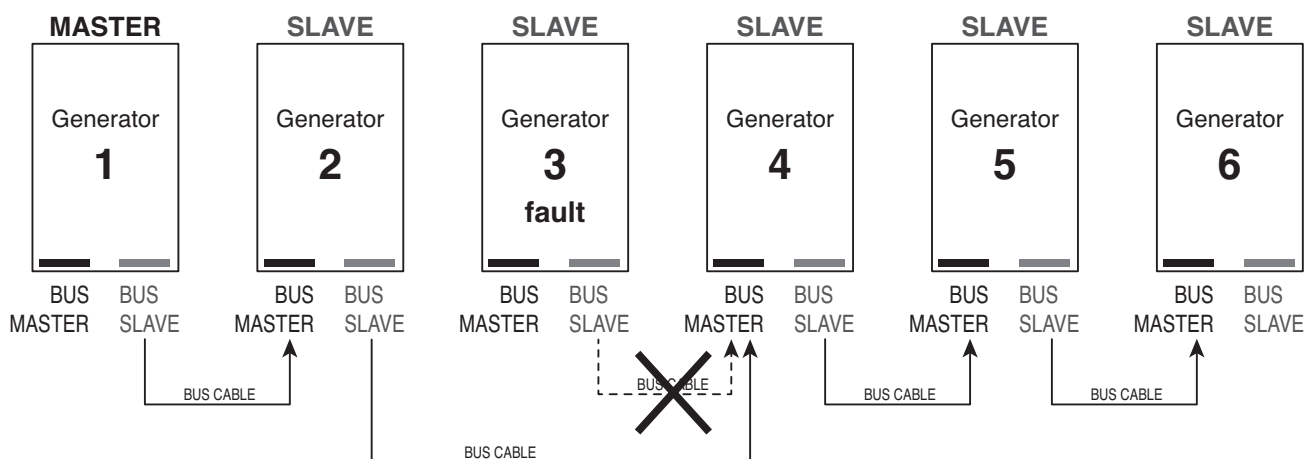

In this case, to exclude the generator to be repaired from the cascade sequence, the previous generator simply needs to be connected to the subsequent one in the series, using a BUS connection.

This will require a repeated auto-configuration procedure of the cascade sequence (refer to the instructions on page 6).

If it is the master generator that needs to be excluded, the BUS connection to the second generator (the first slave unit) should be disconnected. The latter thus becomes the MASTER unit. This will then need to be connected to the pump and cascade sensor, boiler thermostat/sensor and heating request connectors (TA, outside sensor, 0-10V).

In this case the entire cascade sequence programming phase must be repeated (see instructions on page 5).

⚠ WARNINGS

- Before making any type of electrical connection, ensure that the power mains is disconnected from the generators, the and that the main system switch is set to “OFF” .
- In the case of low voltage **BUS connections** **IT IS COMPULSORY** to use different routes from those of the mains voltage cables and ensure that these cables are as short as possible.

The BUS CABLE connection between the generators in the cascade sequence is **SERIAL** and not parallel and therefore the connections must be made as specified below:

| Generator MASTER | Generator SLAVE |
|------------------|-----------------|
| 5 V | 5 V |
| GND | GND |
| TX | RX |
| RX | TX |

Collegamenti CAVO BUS specifici per gruppi termici S-AF and S-AF XL

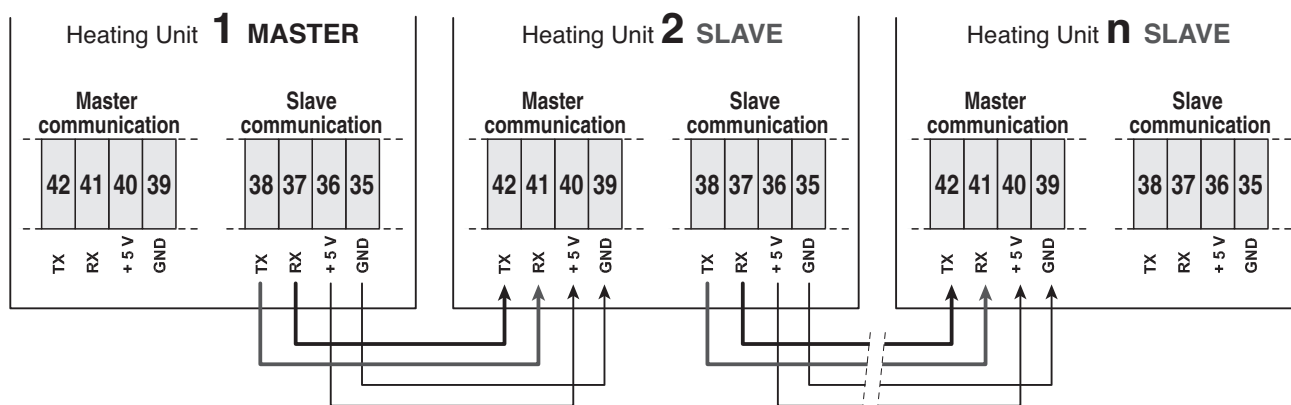

PROGRAMMING







After making the BUS connections between the various generators in the cascade sequence, the configuration must be entered by modifying the parameters accordingly.

 **THE CONFIGURATION IS ENTERED EXCLUSIVELY ON THE MASTER GENERATOR.**

ACCESS TO THE TECHNICAL MENU FROM THE MASTER GENERATOR

Access to the technician menu requires entry of the PASSWORD "231".

The procedure is as follows:

- press  TWICE followed by 
- press  THREE TIMES followed by 
- press  ONCE followed by .

For a maximum of 15 minutes, the system enables exit and subsequent re-entry to the technician menu without the need to enter the password. On elapse of this interval, entry of the password is required again to access the technician menu.

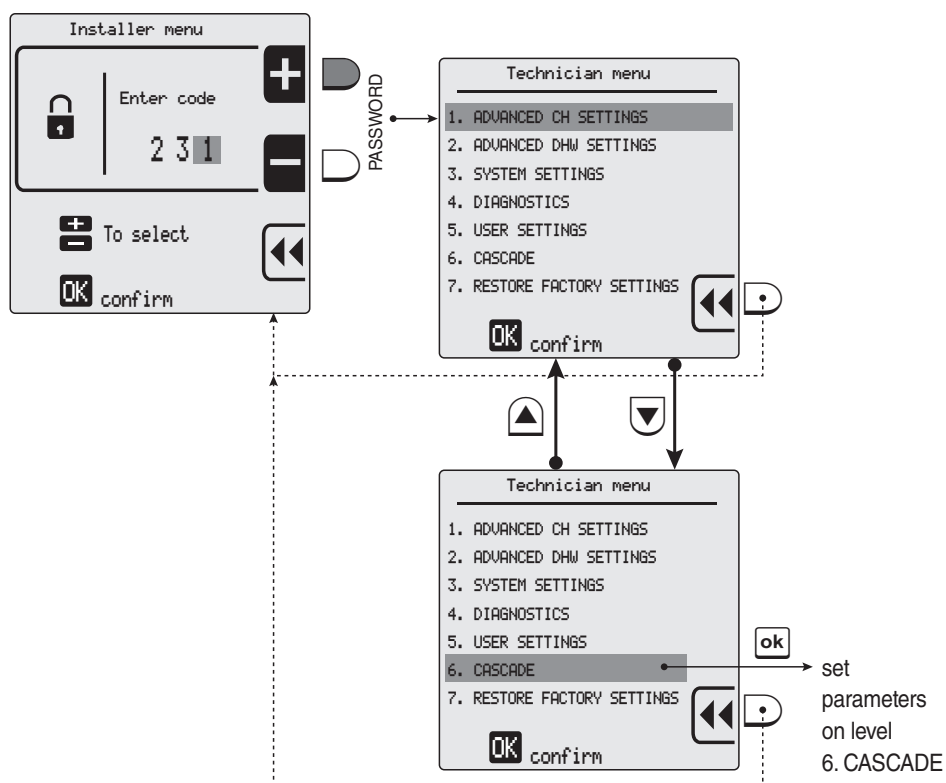

Scroll through the menu to level "6. CASCADE" and set the parameters as required according to the selected hydraulic configuration.

The parameters of level “6. CASCADE” are described below.

| TECHNICIAN MENU | Keys | Sub-menu | Keys | Sub-menu | Keys | Lines | Keys | Factory setting | Field |
|-----------------|-----------------------|----------------|------|---------------------------|-------|-------|------|-----------------|------------------|
| 6.CASCADE | [ok] | 1. Cascade set | [ok] | 1. Cascade switch delay | [ok] | --- | --- | 60s | 0÷255 s |
| | | | | 2. Cascade min power | | --- | | 14% (**) | 0÷100% |
| | | | | 3. Single burner power | | --- | | (*) | 0÷2550kW |
| | | | | 4.Boiler for DHW | | --- | | 0 | 0÷6 |
| | | | | 5.PI loop period | | --- | | 4s | 1÷15 s |
| | | | | 6.Burner water flow delay | | --- | | 30s | 0÷255 s |
| | | | | 7.Different boiler size | | --- | | Disabled | Enabled/disabled |
| | | | | 2.Cascade info | | --- | | --- | --- |
| | 3.Cascade auto-detect | --- | --- | --- | ----- | | | | |

(*) 115 kW for S-AF and S-AF XL..

(**) 18% for S-AF and S-AF XL.

On completion of entry of the cascade parameters, enter level “6.3 CASCADE AUTODETECT” and start the auto-configuration procedure. At the end of this procedure, the user must then confirm (if correct) the number of generators detected in the cascade sequence.



Before launching auto-configuration, ensure that all boilers are wired correctly, powered and are on stand-by (or in error status).

The auto-configuration procedure is required on initial installation, or after a change to the number of generators or their order in the cascade sequence, or when the configuration of the master generator parameters are modified.

KEY TO MENU ITEMS

| Ref. menu line | Line title | Meaning |
|-------------------|-------------------------|--|
| 6. CASCADE | | |
| 6.1.1 | Cascade switch delay | Time interval that needs to pass between the ON command input and effective start-up of the burner |
| 6.1.2 | Min. modulation power | Minimum available power in cascade (Minimum Pn of a boiler) |
| 6.1.3 | Single burner power | Maximum power of single burner |
| 6.1.4 | Boiler for DHW | Number of generators dedicated to DHW, as well as to heating. These generators MUST first be connected to the communication BUS, and then it will always be the MASTER and any other units (e.g. if there are 3 units, these will comprise a Master unit, the first slave and the second slave). |
| 6.1.5 | PI loop period | Time interval for recalculating power requirements. On elapse of this time interval the system checks a measurement cycle and calculation of the power requirements. |
| 6.1.6 | Burner water flow delay | Delay of response of control algorithm according to hydraulic structure. In the case of cascade configurations with disconnecter, it is possible to balance the time in which a temperature variation, read by the cascade sensor, is effectively received by the control board. This prevents, on start-up of a single boiler, the cascade sensor from detecting a temperature variation in time, blocking the system due to a "cascade sensor error" Before setting to error status, the system waits for this additional time interval. |
| 6.1.7 | Different boiler size | Enables/Disables algorithm-based control of cascade configurations of boilers with different outputs (e.g. in the presence of a low power generator dedicated to DHW production). In the case of combining several generators of the same output, this algorithm does not need to be enabled. |
| 6.2 | Cascade info | Display of information on the cascade configuration |
| 6.3 | Cascade autotdetect | Start of cascade auto-configuration process. |

More information on possible combinations of parameters on levels

6.1.4 BOILERS FOR DHW and 6.1.7 BOILERS OF DIFFERENT SIZES

There are three possible combinations for the parameters “6.1.4 Boilers for DHW” and “6.1.7 Boilers of different sizes”. Each of these enables different operating logics for the generators in the cascade sequence.

The "basic" logic adopted by the system in managing the cascade sequence is as follows:
MAINTAIN THE GREATEST NUMBER OF GENERATORS POWERED AT THE MINIMUM POSSIBLE LEVEL.

To do this, it is presumed that ALL generators are IDENTICAL (same Nominal Power and Minimum Power). In this case all generators in the cascade sequence meet the request for heating and domestic hot water, with priority or not.

The parameter “6.1.4 Boiler for DHW” enables the identification of a sub-group of generators to meet the request for domestic hot water. In this case, on the request for domestic hot water, only this sub-group of generators is activated to meet the DHW request, while the remaining units remain active to meet the heating request

The parameter “6.1.7 Boiler of different size”, if enabled, enables a group of generators to be dedicated also to DHW, with different sizes with respect to that dedicated exclusively to heating.

However there is the constraint that in the group exclusively dedicated to heating, all generators must be of the same power rating. In this case the parameter “6.1.3 Single burner power” will coincide with the maximum nominal power of these generators.

The following section provides an example of the application of the three different operating logics, considering a sequence of 4 generators in cascade. The correct application of each logic depends on the correct previous hydraulic configuration.

Example 1

All 4 generators of the same rated power, configured to meet both heating and DHW requests. $P_n = 600kW$, $P_{min} = 100kW$

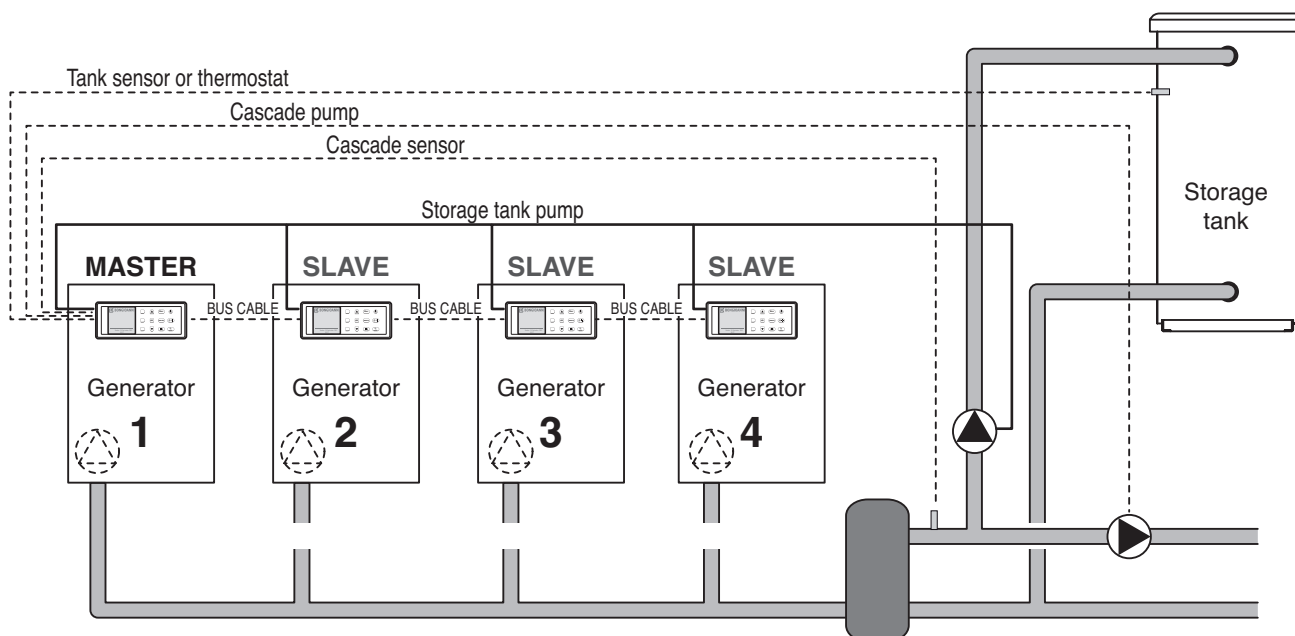

- 6.1.2 Min. modulation power = 100
- 6.1.3 Single burner power = 600
- 6.1.4 Boiler for DHW = 0
- 6.1.7 Different boiler size = 0.

In this case the generators are managed according to the general cascade logic (both for heating and DHW requests), modulating on the basis of the temperature measured by the cascade sensor.

The boiler pump must be connected in parallel with all generators in the cascade sequence (ideally via relay), to respect DHW outputs.

Example 2

All 4 generators of the same rated power, configured to meet heating requests. ONLY the first two generators are set also to respond to DHW requests. $P_n = 600kW$, $P_{min} = 100kW$

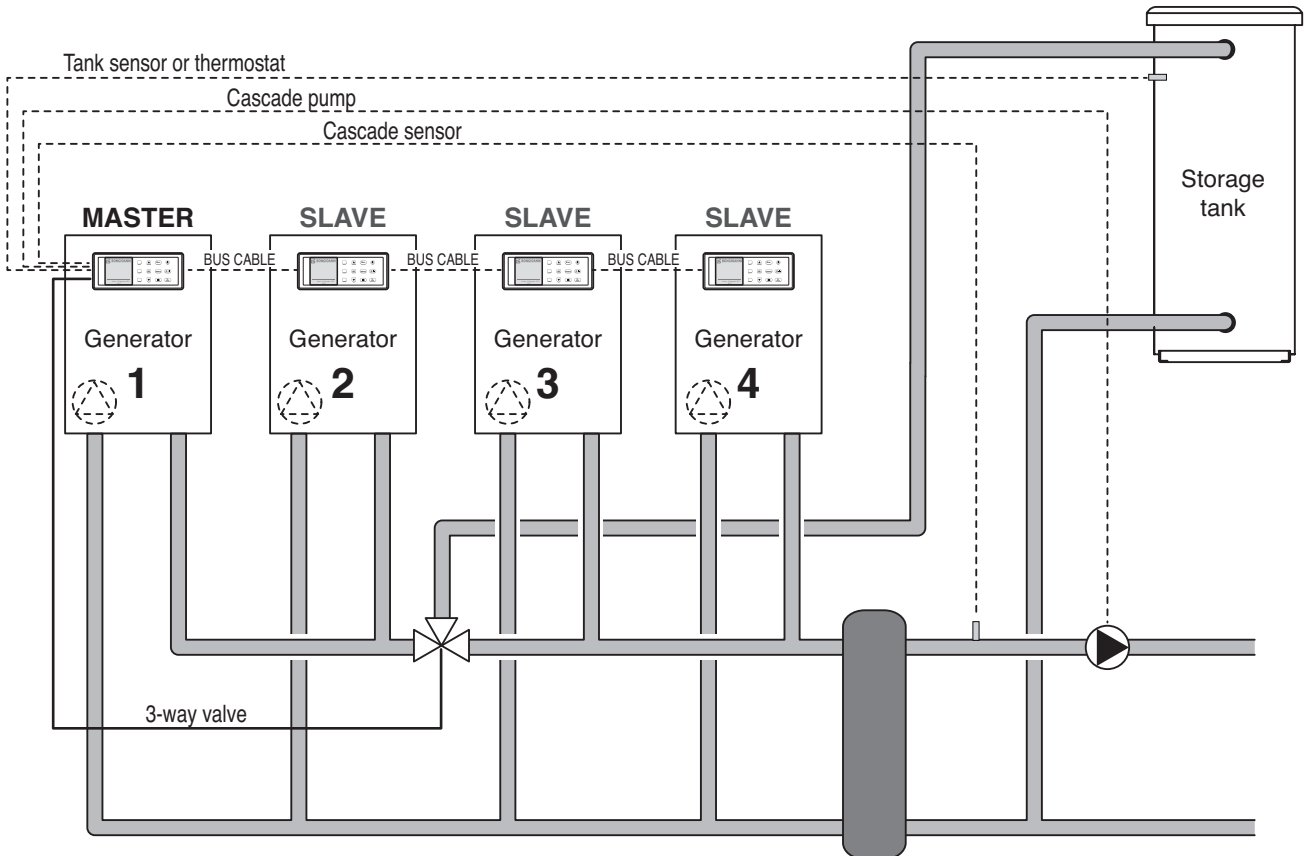

- 6.1.2 Min. modulation power = 100
- 6.1.3 Single burner power = 600
- 6.1.4 Boiler for DHW = 2
- 6.1.7 Different boiler size = 0.

In this case, for heating requests all generators are managed according to the general cascade logic, modulating and using the temperature measured by the cascade sensor. When a DHW request is sent, ONLY the generators dedicated to DHW will meet this request.

The 3-way valve can be connected to any one of the DHW generators. We recommend connecting to the first (master) for optimal BUS communication speeds.

Example 3

2 generators of the same rated power dedicated to meet the heating request, and 2 dedicated generators to meet both heating and DHW requests.

ADVANCED CH SETTINGS: $P_n = 600\text{kW}$, $P_{min} = 100\text{kW}$

HEATING+DHW: $P_n \neq 600\text{kW}$, $P_{min} \neq 100\text{kW}$ (any power other than 600 / 100 kW)

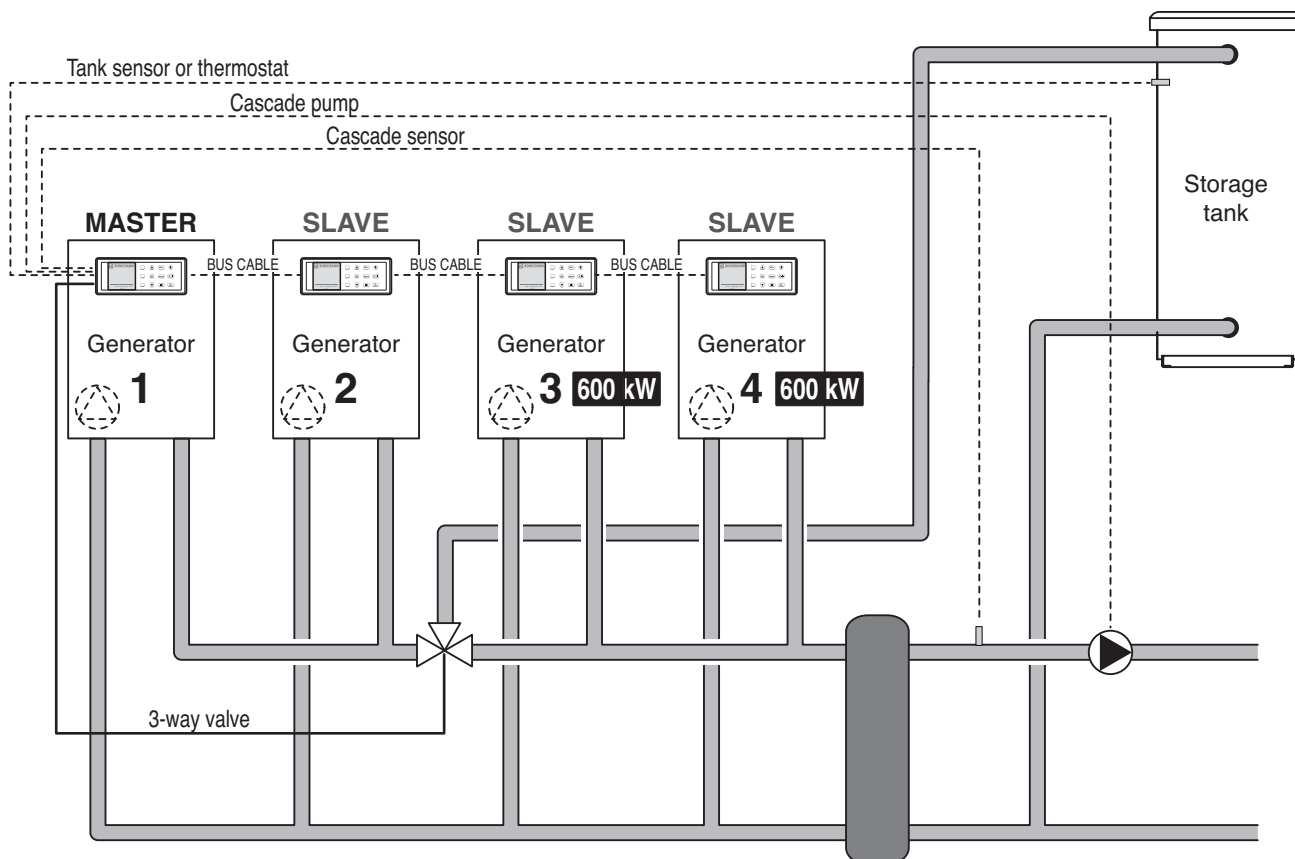

- 6.1.2 Min. modulation power = 100
- 6.1.3 Single burner power = 600
- 6.1.4 Boiler for DHW = 2
- 6.1.7 Different boiler size = 1.

In this case, ONLY for heating requests, the generators dedicated to HEATING ONLY are managed according to the general cascade logic, modulating and using the temperature measured by the cascade sensor. If all generators dedicated to heating reach 100% capacity, then and only then are DHW generators activated, all together as a back-up to the first generators (modulating the power accordingly).

When a DHW request is sent, ONLY the generators dedicated to DHW will meet this request.

The 3-way valve can be connected to any one of the DHW generators. We recommend connecting to the first (master) for optimal BUS communication speeds.

EXAMPLE OF POWER SUPPLY PANEL

TYPE OF POWER SUPPLY PANEL FOR 6 BOILERS
Power connections

ICT - Residual current thermal-magnetic cutout with opening coil controlled by a release button, to protect indirect contacts of the line and boiler power supply panel. To be installed in the vicinity of the heating set. General sizing: task of client.

- IG** - Main switch
- IS** - Safety module switch
- TMAX** - Maximum thermostat
- PMAX** - Maximum pressure switch
- KS** - Safety module contact
- IP** - Main switch
- XS1** - External socket
- FA** - Fuse-holder disconnecter 1 Pole + Neutral
- LA** - "Auxiliary circ. ON" indicator light (green led)
- QC1÷6** - Boiler Panel 1÷6
- AC1÷6** - Boiler power supply 1÷6

(*) for Multidea Evo models only.

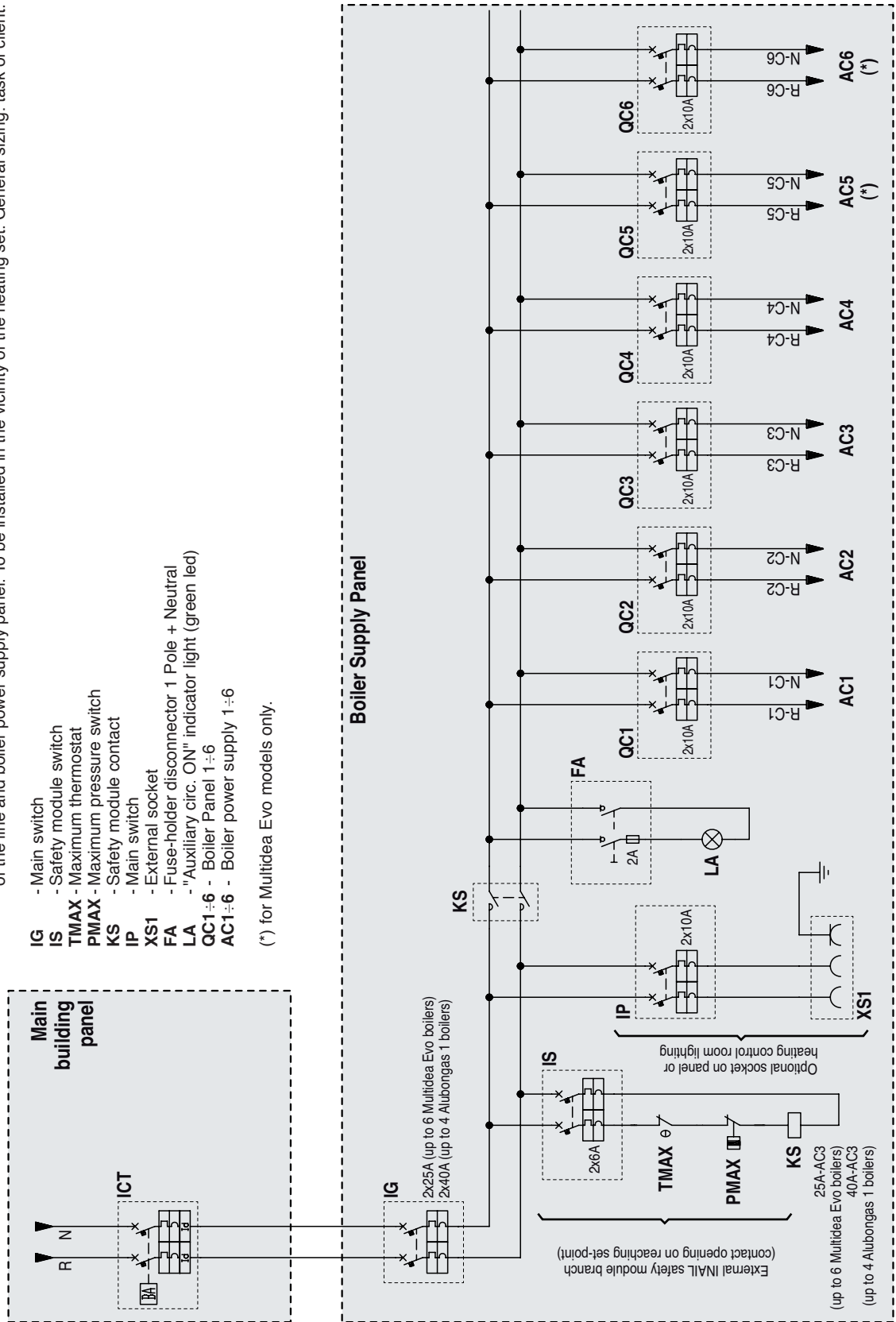

Strebel Ltd

1f Albany Park Industrial Estate,
Frimley Road, Camberley,
Surrey, GU16 7PB

Tel: 01276 685422

Fax: 01276 685405

Email: info@strebel.co.uk

Web: www.strebel.co.uk



Further information on our complete product range is available from our website.

CAST IRON – CONDENSING – STEEL SHELL – WATER HEATERS – RENEWABLES

FLUES – ACCESSORIES – RADIATORS